

MULTIFLEX Plus

Safely and efficiently forming
with new System Components



Flexclip
Distance Device
Fixing Tool

MULTIFLEX Plus

Flexclip, Distance Device and Fixing Tool

With the new MULTIFLEX Plus components

- Flexclip
- Distance Device
- Fixing Tool

the proven and universally applicable MULTIFLEX slab formwork is even safer to use. The cross beams are positioned on the main beams secured against tilting.



■ Flexclip

For securing the cross beam against tilting on the main beam. Assembly is safely carried out from the erection level with the Distance Device or the Fixing Tool.

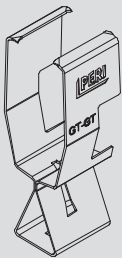

■ Distance Device

For safer and fast installation of the VT 20K and GT 24 cross beams as well as for setting and spreading the Flexclips from the erection level.

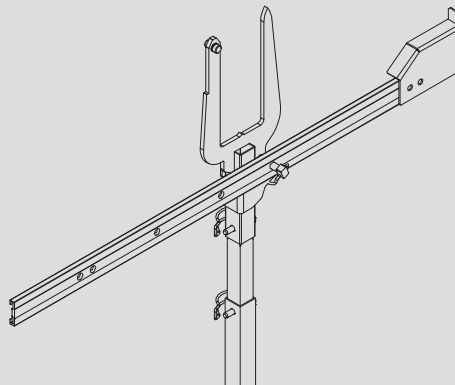

■ Fixing Tool

For safely setting and spreading of the 3 different Flexclips from the erection level. It can be mounted on an extension.





The PERI Flexclip secures the cross beams against tilting and is available in 3 versions, according to the girder combination.

■ **Assembly**

Forming with MULTIFLEX as usual from the erection level. The Fixing Tool is complemented by the Distance Device and thus greatly simplifies installation of the cross beams.

The pre-determined girder spacing on the Distance Device means that measuring of the cross beam spacing is no longer necessary. With the mounting of the Flexclips, the cross beams are secured against tilting.

Take up Flexclip with the Fixing Tool, attach to the cross beam and pull down the Fixing Tool - ready.



Fast and safe installation and aligning of the main beams with the Fixing Tool.



Using the same Fixing Tool, the Flexclips are also safely mounted from the ground.

Item no.	Weight kg
116614	0,538

Flexclip GT/GT
To connect GT 24 with GT 24 Girders.

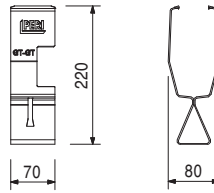

116605	0,493
--------	-------

Flexclip GT/VT
To connect GT 24 with VT 20 Girders.

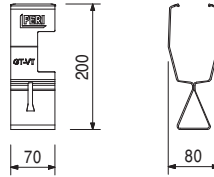

116596	0,467
--------	-------

Flexclip VT/VT
To connect VT 20 with VT 20 Girders.

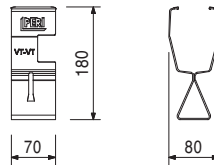
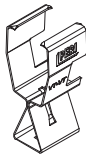

117575	0,166
--------	-------

Fixing Tool MF-Plus
For assembling the Flexclips.

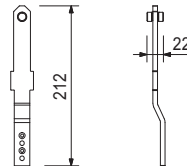
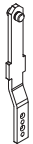

117574	3,100
--------	-------

Distance Device MF-Plus
To fit and align the formwork girders as well as assemble the Flexclips.

