

VBC Balanced Cantilever Carriage and VIL Incremental Launching Facility VARIOKIT systems for construction of large bridges

Product Brochure – Issue 04/2019



Content

Construction of Large Bridges

- 5 VARIOKIT system solutions

VBC Balanced Cantilever Carriage

- 6 System advantages and areas of application
- 8 Detailed solutions
- 10 Project examples

VIL Incremental Launching Facility

- 14 System advantages and areas of application
- 16 Detailed solutions
- 18 Project examples

Issue 04/2019

Publisher

PERI GmbH
Formwork Scaffolding Engineering
Rudolf-Diesel-Strasse 19
89264 Weissenhorn
Germany
info@peri.com
www.peri.com

PERI Civil Engineering Solutions

- 20 VARIOKIT system solutions and services from one source
- 22 Applications with the VARIOKIT Engineering Construction Kit
- 24 Individual services for customised bridge and tunnel construction

Important Information

All current safety regulations and guidelines applicable in those countries where our products are used must be observed.

The images shown in this brochure feature construction sites in progress. For this reason, safety and anchor details in particular cannot always be considered conclusive or final. These are subject to the risk assessment carried out by the contractor.

In addition, computer graphics are used which are to be understood as system representations. To ensure a better understanding, these and the detailed illustrations shown have been partially

reduced to show certain aspects. The safety installations which have possibly not been shown in these detailed descriptions must nevertheless still be available. The systems or items shown might not be available in every country.

Safety instructions and load specifications are to be strictly observed at all times. Separate structural calculations are required for any deviations from the standard design data.

The information contained herein is subject to technical changes in the interests of progress. Errors and typographical mistakes reserved.



VARIOKIT system solutions

Cost-effective construction of superstructures

For cost-effective realisation of large bridge structures, special construction methods are used. The most common methods for superstructures include, among other things, the cantilever launching of bridges and the balanced cantilever method. PERI offers system solutions for both.

As a reliable partner, PERI also provides complete solutions for the entire bridge construction - from abutments and foundations through to piers and superstructures.

The rentable system solutions based on the VARIOKIT Engineering Construction Kit can be adapted to suit a wide range of geometries. In addition, the compatibility with the PERI UP modular scaffolding system creates safe working platforms and access to all work areas. With practical and innovative products combined with PERI engineering expertise, PERI always provides the best solution for the customer and the project's success.

PERI engineers take on project-specific planning along with the static calculations of the complete solutions. All systems and processes are thus optimally coordinated with each other and facilitate on-schedule completion. Thanks to the close cooperation between the general contractors, planners and PERI engineers already in the planning phase, the shape of the bridge superstructure, among other things, can be optimised whilst execution times are accelerated – without any interface losses and sources of error.

VBC Balanced Cantilever Carriage

The rentable balanced cantilever carriage for bridge construction in record time



VIL Incremental Launching Facility

The fast, rentable solution with the best handling and reduced material quantities



VBC system advantages and areas of application



With the high load-bearing balanced cantilever carriage, sections up to 5.75 m long can be concreted. If this has already been taken into account during the bridge planning phase, the large section lengths combined with the rational operation of the balanced cantilever carriage can save valuable construction time and make it possible to achieve a weekly cycle.

The PERI VARIOKIT solution for balanced cantilever construction is a combination consisting of load-bearing, specially developed system components for this building method and VARIOKIT core components to complete the supporting structure. Based on the VARIOKIT Engineering Construction Kit, the rentable system components are quickly available. The balanced cantilever carriage can be

adapted flexibly to accommodate a wide range of bridge cross-sections and geometries.

PERI not only delivers customised and load-optimised complete solutions comprised of formwork, balanced cantilever carriage and access solutions from a single source, but also saves on construction time through project-specific engineering - without any interface losses and sources of error.



Reducing construction time thanks to concreting sections up to 5.75 m long, as well as high load-bearing capacity and integrated hydraulics

Cost-effective project solutions by combining practice-oriented and rentable system components based on the VARIOKIT Engineering Construction Kit and project-specific engineering

Safe access solutions in all conditions due to compatibility with the PERI UP modular scaffolding kit

VBC detailed solutions



Lower workload
Only 2 anchors per A-frame required.



No unintentional movement
The equipment is always mechanically secured when being moved forward to the next cycle.



Safe access means
Modular working platforms and access to all working areas due to the compatibility with PERI UP.

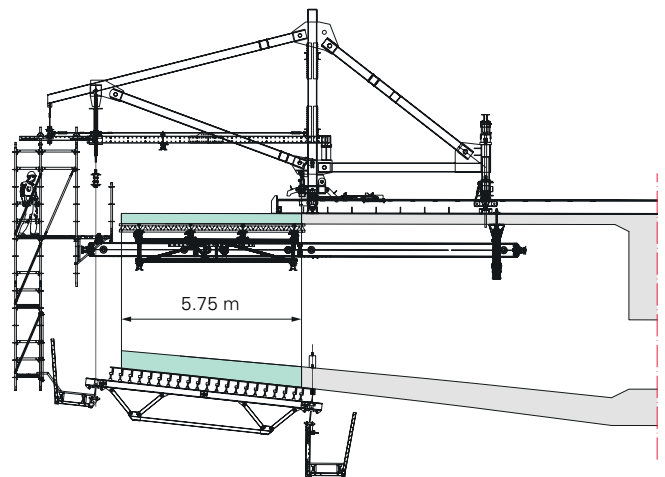

Reduction in construction time
Sections up to 5.75 m long.



Time-saving
Thanks to the fully integrated hydraulics for moving and aligning the formwork, fast and simple to operate.

VBC project examples



Railway Junction Viaduct, Krakow-Plaszow, Poland

Adapted balanced cantilever solution based on the VARIOKIT Engineering Construction Kit

The expansion of Krakow Light Rail KST system required, among other things, crossing the Kraków – Plaszow railway junction. As uninterrupted train services had to be guaranteed for the entire construction period of this 252-m-long crossing, the general contractor decided on using the balanced cantilever method for the extradosed bridge complete with hollow box cross-section. Thanks to the tailored solution realised by the PERI engineers, the construction team achieved 5.70-m-long concreting sections using 4 VARIOKIT Cantilevered Construction Carriages. Due to the high degree of flexibility and simple alignment of the system, the respective sections could be constructed without any interruptions in 2-week cycles.

The integrated, centrally-controlled mechanism with hydraulic cylinders as well as lifting and moving devices for moving, lowering, lifting of the equipment and formwork ensured easy handling of the balanced cantilevered carriage. The hydraulics also simplified the adjusting and positioning of the formwork from section to section.

After closing the gap in a bridge section, the PERI VBC Balanced Cantilever Carriage could automatically return to its starting position although stay cables were positioned along the structure's axis. As a result, dismantling the equipment was efficient and safe. PERI Poland took on the project-specific planning along with the static calculations of the complete solutions for

the superstructure on the sub-structure as well as for the cantilevered construction. Consequently, all systems and processes were optimally coordinated with each other and facilitated on-schedule completion. Thanks to the close cooperation between the general contractors, planners and PERI engineers in the planning phase, the shape of the reinforcing ribs along the bridge superstructure, among other things, was optimised in order to accelerate execution times.



Kičevo-Podvis Motorway Bridge, Northern Macedonia

VARIOKIT cantilevered construction for a problem-free workflow

The 381-m-long motorway bridge is part of the Pan-European Transport Corridor VIII, an international transport axis between Albania and Bulgaria. In the mountainous south-west region of Northern Macedonia, a total of 14 viaducts were built to realise the first sections of the route. The length of around 10 km required excavating more than 4,000,000 m³ of earth as well as processing 150,000 m³ of concrete and 15,000 t of reinforcement.

PERI engineers developed a project-specific solution for Macedonia's longest cantilever bridge. In spite of the challenging terrain, the tight construction schedule was comfortably maintained.

The biggest challenge faced on the four-lane highway section was the viaduct at Kilometer 9, which had to be constructed using the balanced cantilever method. For the bridge piers and superstructure, PERI provided the most cost-effective formwork solution. In particular, the hydraulic solutions for adapting and aligning purposes, along with the independent moving procedure of the formwork carriage, shortened execution times. As a result, the construction team realised a regular 7-day concreting cycle.

Four VBC Balanced Cantilever Carriages from the VARIOKIT Engineering Construction Kit supported the building of the radially arranged bridge superstructure

with a span of 165 m. Thanks to these carriages, it was possible to ensure that the separately executed 12.55-m and 11.55-m-wide carriage-way slabs were completed within the tight project schedule. The superstructure height varied between 9.00 m at the piers and up to 4.00 m in the centre of the bridge. The concreting cycles also varied in length from 3.30 m through to 5.00 m. In addition to the constantly changing superstructure cross-sections, the PERI solution also took into account the constant longitudinal inclination of 2.8%, as well as the variable transverse inclinations of 1.5% to 6.0%.

VBC project examples



Harpe Bru Bridge, Sør-Fron, Norway

VARIOKIT balanced cantilever solution optimised construction progress

The 320-m-long cable-stayed bridge over the Gudbrandsdalen Lågen in the Oppland province is part of the European Route E6 expansion project. For the bridge superstructure, PERI civil engineering technology experts developed a balanced cantilevered solution based on the VARIOKIT system. The extradosed construction method, with the tendons positioned outside of the bridge cross-section, was used for the first time in Norway and allowed a low overall height of the superstructure and pylons. The span between the two pylons is 100 m while two additional piers along with the abutments are positioned on the land.

The PERI solution for forming the 19.60-m-wide superstructure consisted of 4 VARIOKIT Balanced Cantilever Carriages, which were used to realise 5.55-m-long sections in each case. In the process, the system was flexibly adapted to suit the geometric cross-sectional changes and the varying, in part, very high loads with constantly load conditions. In particular, the planning took into account the cable arrangement of the segment suspensions in order to prevent collisions with the balanced cantilever carriage. In addition, 1.30-m-high transverse ribs were realised together with the bottom slab and side walls of the hollow box girders. The carriageway slab was subsequently concreted in a second casting segment.

VARIOKIT minimised the required workload for each bridge section. For example, the convenient moving procedure by means of the integrated hydraulics along with fully hydraulically-operable aligning and adjusting led to optimised cycle times. Furthermore, the detailed implementation plans and technical documentation ensured on-site formworking operations could be easily and efficiently carried out. The high proportion of system components from the VARIOKIT Engineering Construction Kit, as well as the high availability of materials in the PERI rental park, ensured a high level of cost-effectiveness.



Chachenka Bridge, Moscow, Russia

VARIOKIT cantilevered construction in 10-day cycles

The motorway bridge over the Chachenka River is an integral part of the 18.5-km-long road construction project that connects the Moscow MKAD motorway ring with the M1 Highway, as well as bypassing the town of Odintsovo which is situated to the west of the Russian capital. Known simply as the "Belarus", the M1 between Moscow and Minsk in Belarus is one of the most important road connections in Russia. The bridge structure is 550 m long and consists of two parallel superstructures with double-cell hollow box cross-sections, each 22.25 m wide and 4.00 m high. The individual span widths of the six bridge sections range from 57 m to

110 m, realised using the balanced cantilever method. A total of 10 sets of VARIOKIT Balanced Cantilever Carriage were used simultaneously in order to symmetrically realise - starting from the piers – each of the 12 sections with cycle lengths between 3.40 m and 4.10 m until the gap was closed in regular 10-day cycles.

PERI Russia delivered the cantilevered construction carriage and formwork from a single source, optimally adapted to match the project requirements. In addition, the use of rentable VARIOKIT system components was extremely cost-effective. The integrated, centrally-controlled mechanism with hydraulic

cylinders, as well as lifting and moving devices for moving, lowering, lifting of the carriages and formwork, ensured easy handling of the balanced cantilevered carriage. Shuttering and striking along with moving from cycle to cycle was carried out with only a team of six. Through compatibility with the PERI UP modular scaffold, front-mounted working platforms and access means were also part of the comprehensive PERI project solution.

VIL system advantages and areas of application



External, internal and slab formwork for bridges can be systematically and cost-effectively realised with the VARIOKIT VIL Incremental Launching System. Based on the VARIOKIT Engineering Construction Kit, rentable project solutions can be created in order to accelerate and rationalise work operations.

At the heart of the formwork solution is the Wall Support in combination with the Roller Drophead and Cross Swivel Head. Thanks to innovative system components, savings are made not only regarding materials but also valuable working time. Due to the possibility of fast striking, reduced material transport in the construction process, the simple moving procedure of the slab formwork, as well as the fact that no scaffolding tube bracing is needed, the quantity of formwork materials required on the construction site is significantly reduced – while the work processes are simultaneously greatly accelerated.

By reducing the number of special components, a rentable system solution of almost 100 % has been created. The components are quickly available which means no pre-investment is necessary – also for radii and lateral inclinations with a high proportion of rental parts.

The accelerated and simplified workflows make VIL a profitable solution for a particularly high level of performance and effectiveness in bridge construction.

Accelerated working operations

Fast striking and a clever shuttering method

Easy handling

with reduced manual material transport in the construction process

Reduction in the number of lost components

through a well-thought-out anchoring procedure



Wall Support



Roller Drophead



Cross Swivel Head

VIL detailed solutions

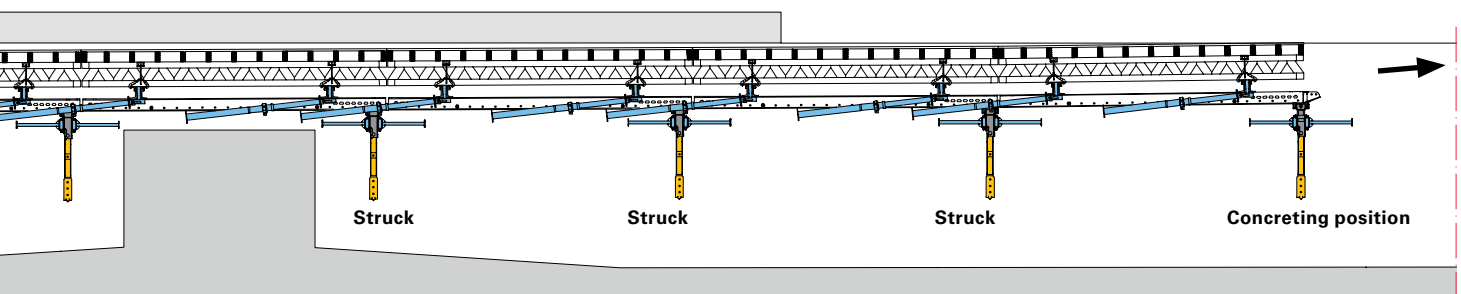
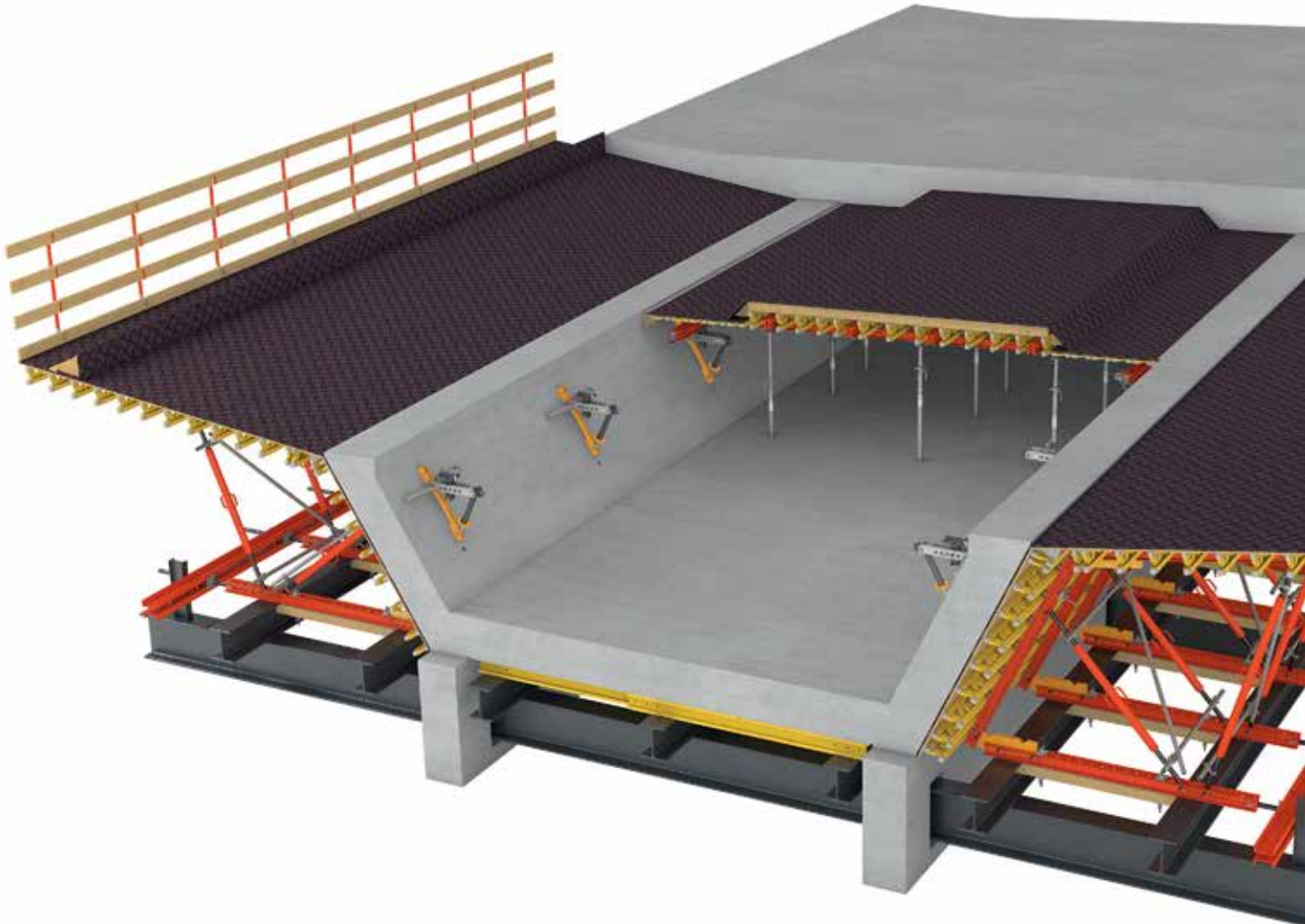

Clever shuttering method

Quickly returned to the concreting position thanks to the ramp technique for travelling. Rollers integrated in the Roller Drophead, in combination with the Wall Support, facilitate easy and simple moving of the slab formwork.

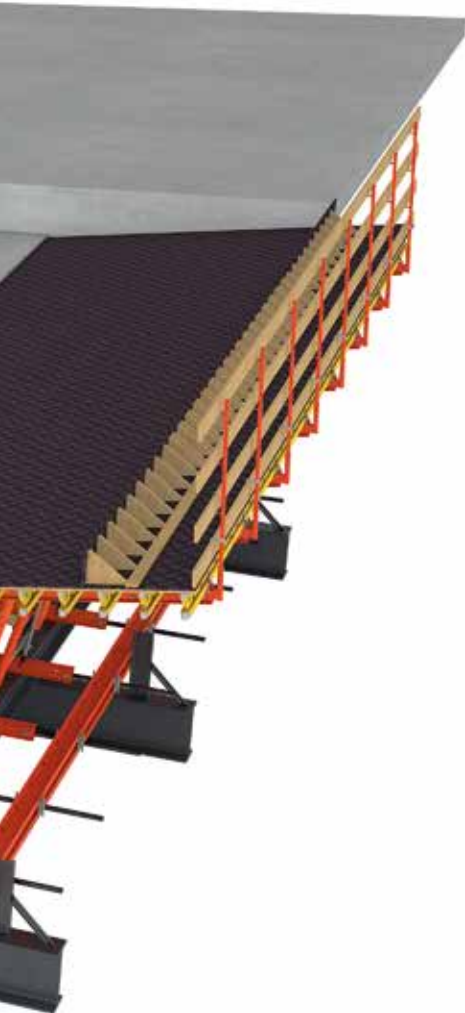

Few lost components

The clamping holes of the wall formwork can be used for anchoring the Wall Supports. The well-thought-out anchoring procedure reduces costs.



Fast assembly

Time-consuming scaffold tube bracing is no longer required.



External formwork

The flexible VARIOKIT formwork units can be individually adapted to suit the supporting construction and bridge geometry.

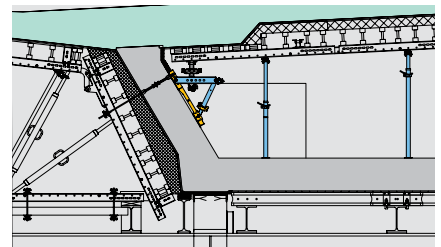

Minimum material requirements

Transfer of concreting loads through the Wall Support; inclined props in the edge areas can be dispensed with.



Fast striking

Due to the quick striking mechanism of the Roller Drophead, also in confined spaces – one hammer blow is sufficient.

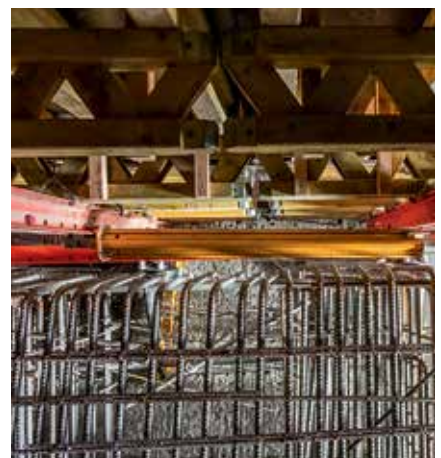

Reduced manual material transport

Horizontal folding of the props by 90° due to the new Cross Swivel Head. Props do not have any load-bearing role when passing over span boxes and cross beams, and therefore do not have to be dismantled and transported by hand.

VIL project examples



Overpass WA 458 over the A1 Motorway, Gliwice, Poland

Well-thought-out solution facilitated compliance with the planned construction time schedule and budget

PERI designed and delivered a flexible formwork solution that could be used for a number of different bridge geometries to realise the 396-m-long incrementally launched bridge construction.

The PERI solution made it easier to move the formwork whilst accommodating the variable bridge geometries. The project-specific solution guaranteed reliable execution and ensured

that the planned construction schedule and budget were complied with throughout. The delivery of pre-assembled units also saved valuable assembly time on the jobsite.

By combining with PERI UP Flex Stairs, safe access solutions could be realised. The lightweight aluminium flights of stairs can be easily and quickly assembled.



S7 Motorway, Section 1 Lubień – Rabka-Zdrój, Poland

Extensive range of services and products ensured the success of the project

The motorway bridge has a total length of 1658 m and was constructed using 39 sections, each 30 to 50 m in length, with the incremental launching method.

Training to ensure the safe use of the systems and solutions that make it easier to move the formwork facilitated compliance with the very tight con-

struction schedule. PERI's logistical expertise and just-in-time deliveries from the PERI rental park ensured that the required quantities of formwork and scaffolding materials were always available on the construction site at the right time. In addition, PERI UP Flex access means and working platforms provided safe work operations in all weather conditions.

VARIOKIT system solutions and services from one source

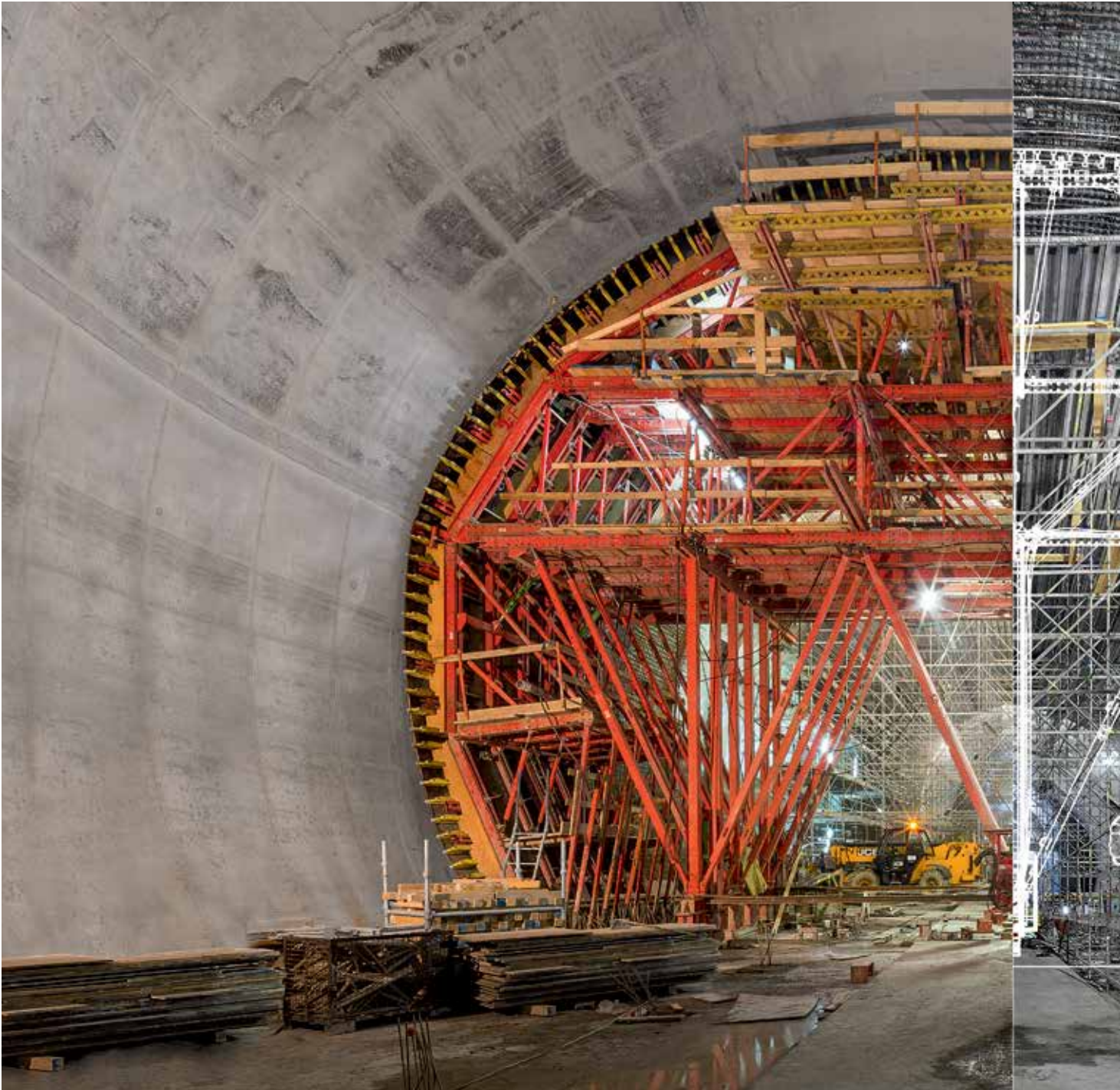

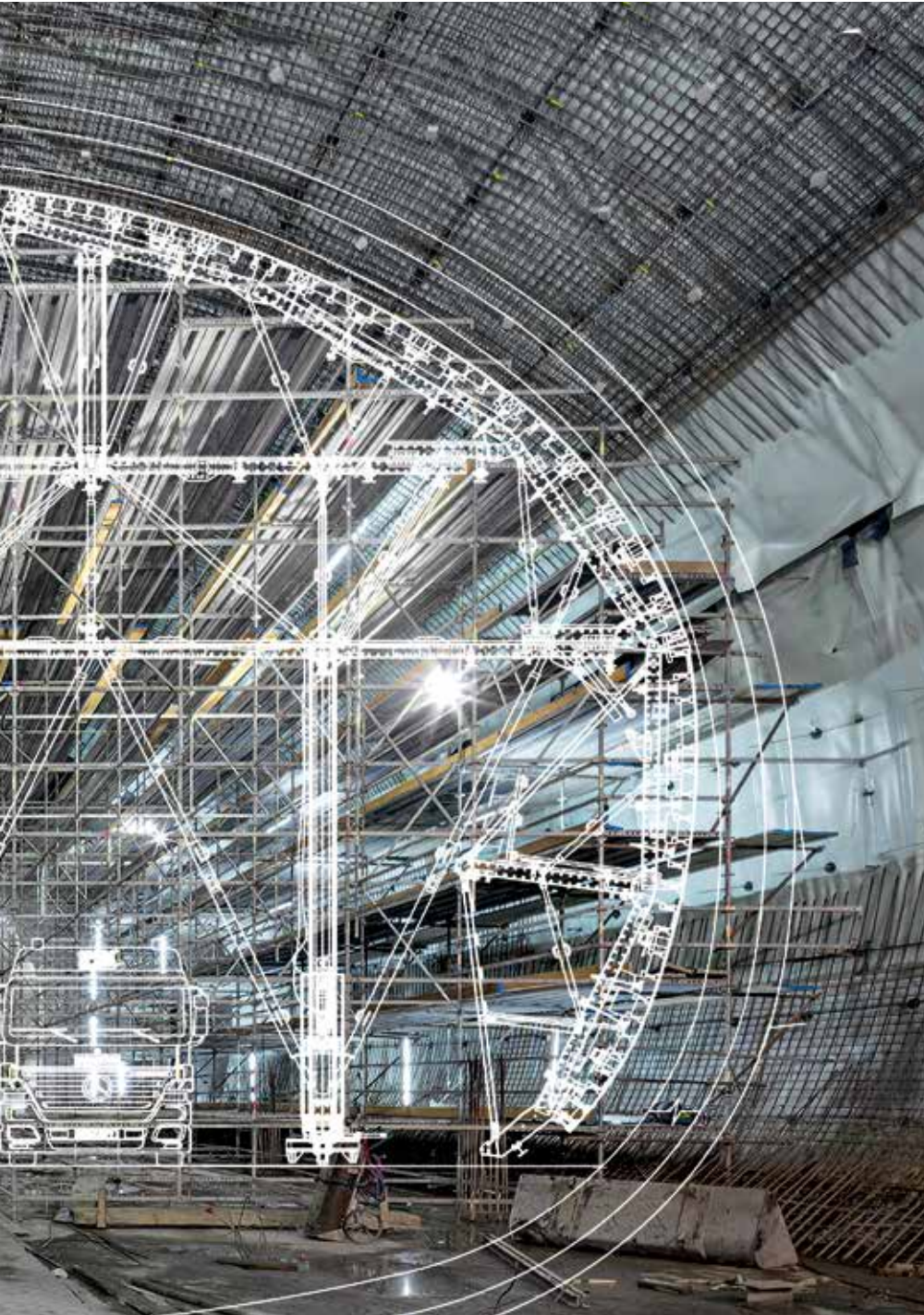

Every bridge and tunnel construction requires project-related planning. With its extensive know-how and expertise, PERI provides not only the required materials but also the complete planning services from a single source.

PERI solutions take into account building and assembly processes along with the maximum functionality for the construction work. With well-engineered technical planning, PERI provides cost-efficient solutions that are optimised on a project-specific basis and are precisely tailored to meet the requirements of the job-site. Technical project solutions with VARIOKIT and services from one source accelerate the work process enormously.

Applications with the VARIOKIT Engineering Construction Kit

VARIOKIT solutions are typically comprised of around 95% rentable core and system components. In order to fulfil specific project requirements, only a few special components are needed.

VGB Parapet Track

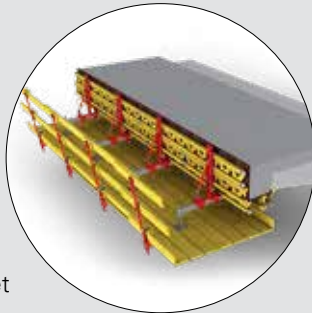
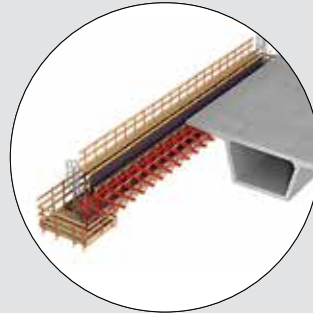

VGK Cantilevered Parapet Bracket



VGW Parapet Carriage



VCB Cantilever Brackets



VTC Tunnel Formwork Carriage



VRB Heavy-Duty Truss Girder



VST Heavy-Duty Shoring Tower

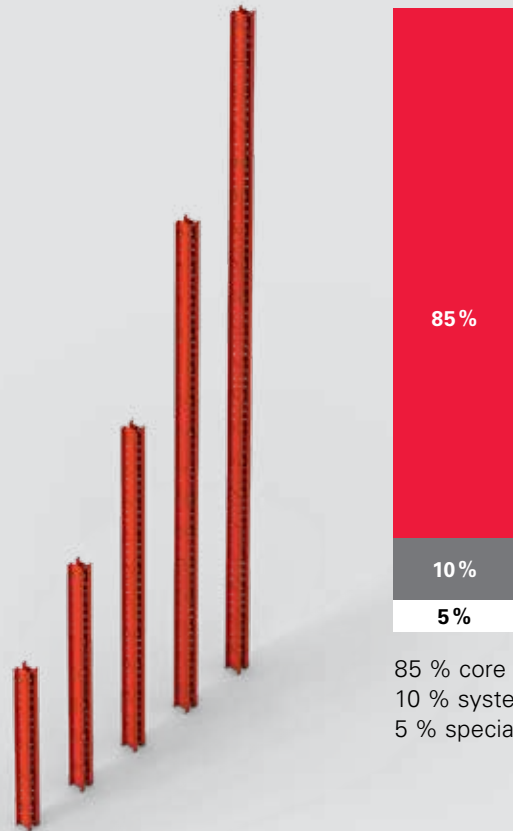
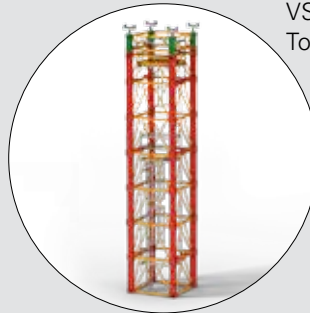

85 % core components
 10 % system components
 5 % special components



VBC Balanced Cantilever Carriage

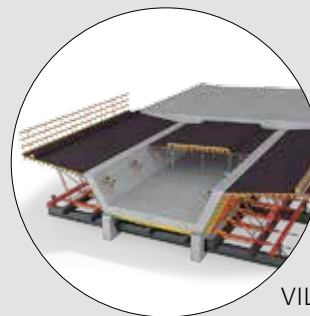

VIL Incremental Launching Facility



VCC Composite Formwork Carriage

Individual services for customised bridge and tunnel constructions

In addition to the required materials, PERI also provides a comprehensive range of expertise, as well as the complete planning services from a single source. PERI solutions take into account building and assembly processes along with the maximum functionality for the construction work. For the planning, PERI pays great attention to maximising the utilisation of the rentable core and system components in order to provide customers with particularly cost-effective solutions.

Around 1,300 PERI engineers worldwide plan and design formwork and scaffolding solutions for cost-effective executions. All PERI Engineering planning services are aimed at ensuring that PERI formwork and scaffolding systems in construction operations are always used in line with time, cost and quality standards. The basis for this is the execution plan records which are based either on 2D-views and sections or realistically visualised 3D building models. As a result, technical solutions are developed with customers that optimise the use of materials and the construction process itself.

These planning-related services from PERI Engineering are supplemented by verifiable, static calculations as proof of stability for formwork and scaffolding operations, as well as by project-specific installation and assembly plans for the professional implementation of special applications. Construction site personnel can use the plans to assemble the individual PERI components correctly and prepare them for use.

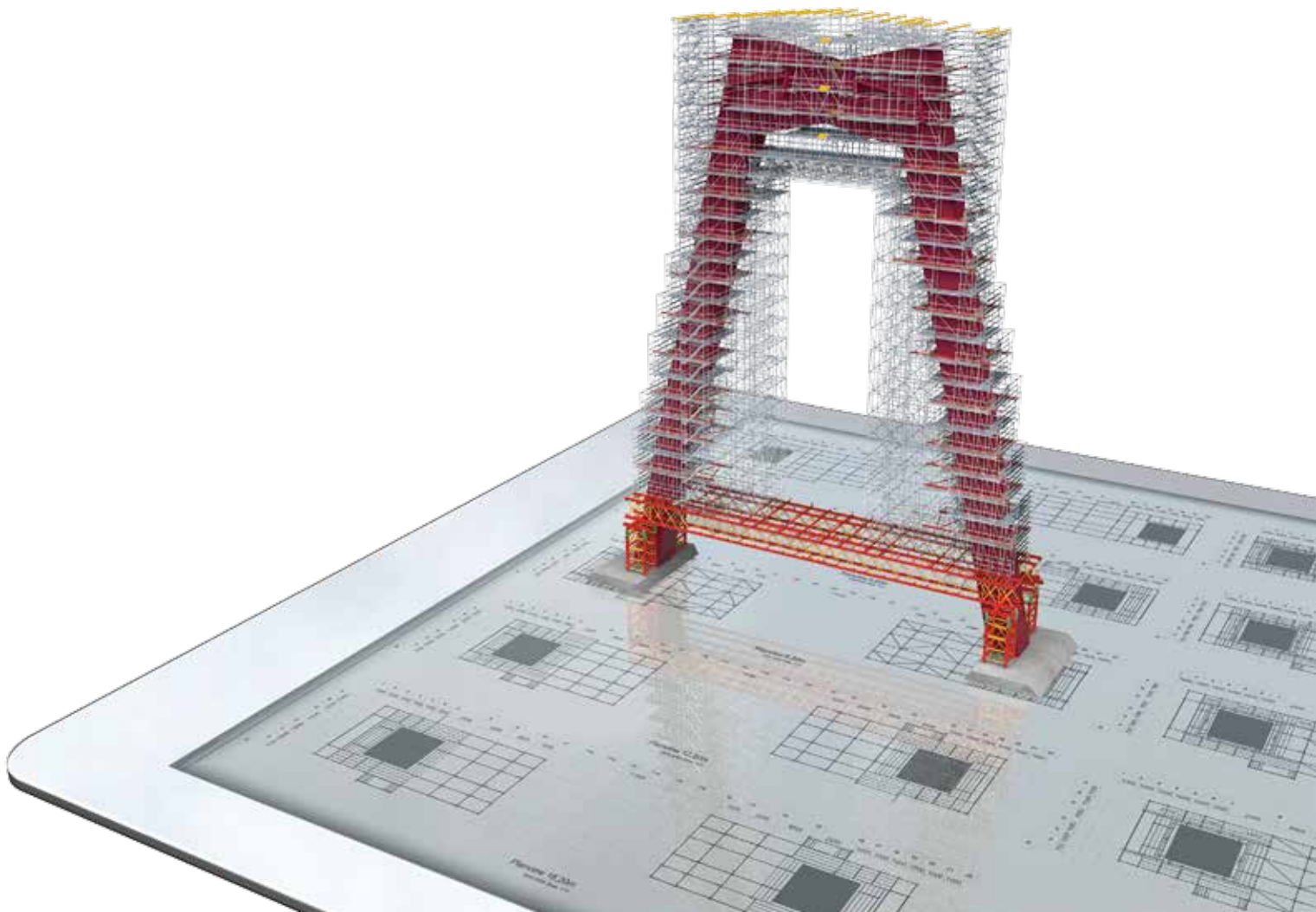



A consistent CAD planning process is realised by bundling the formwork and scaffolding planning.



As implementation plans are coordinated, it becomes much easier and quicker to organise subsequent plan changes and put them into practice.



PERI supervisors also explain plans and parts lists along with providing information on the maintenance, cleaning and storage of PERI materials. If required, they will provide the construction team with comprehensive on-site support to ensure efficient use of PERI system equipment from the very start.



In order to minimise on-site assembly times and maintain tight construction schedules, PERI also provides – if required – pre-assembled units to the construction site. VARIOKIT is extremely cost-effective, especially with short utilisation times, thanks to the rentable components and assembly advantages.



When it comes to BIM, PERI has been one of the leading companies in the industry for many years now and can already show a number international project references that have been successfully developed with customers using BIM principles.

Through the additional integration of the time and cost factors, the 3-dimensional visualisation of the planning gradually turns into a 4D or 5D model. Additional process data relating to formwork and scaffolding technology, such as required plan changes, automated collision checks, safety checklists and QR codes for object navigation, are documented and tracked in a mobile building information management system. All relevant data is available on the construction site via tablet solutions for day-to-day operations.

PERI International

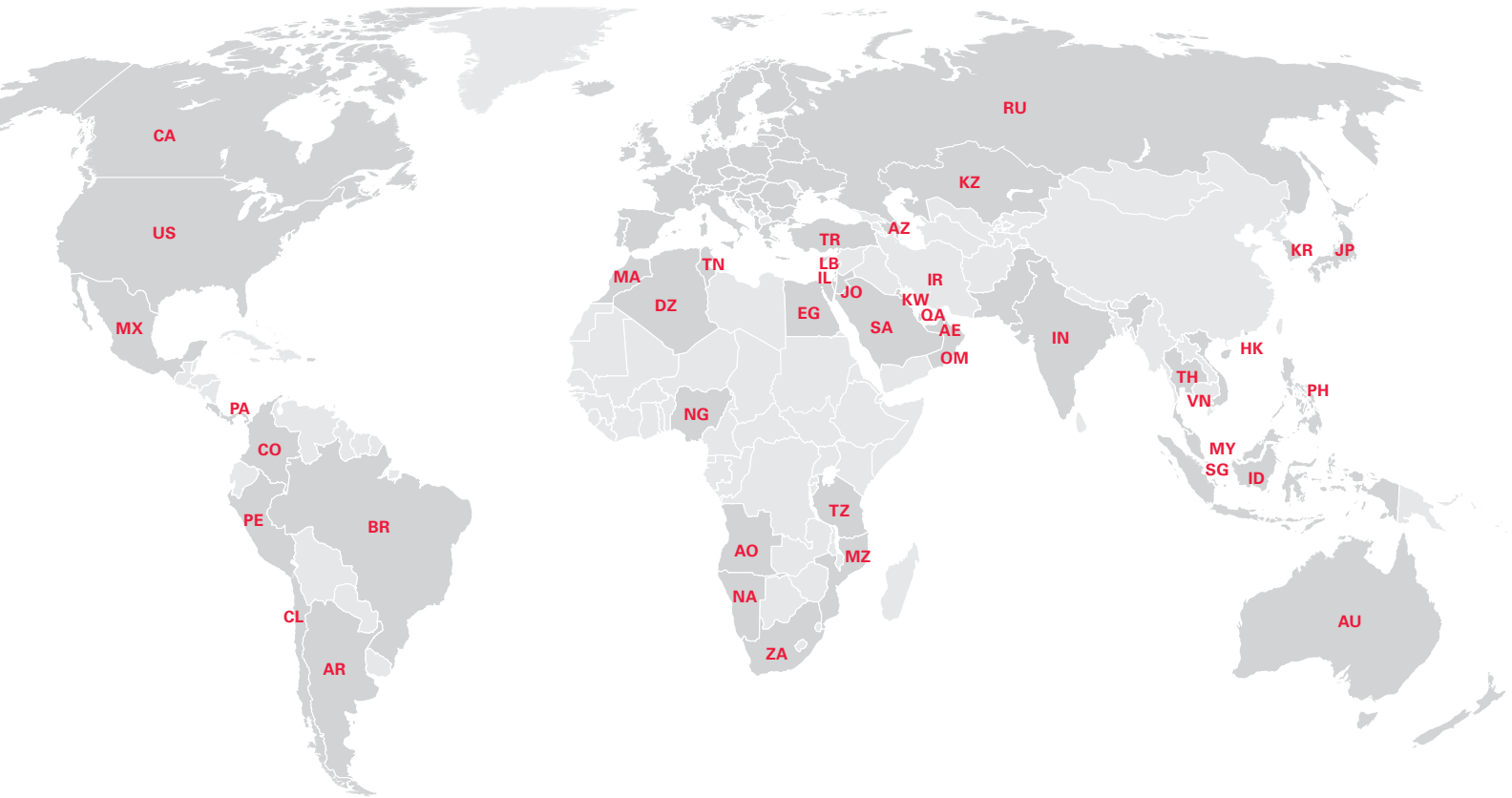

North America

- CA** Canada
PERI Formwork Systems, Inc.
www.peri.ca
- MX** Mexico
PERI Cimbras y Andamios, S.A. de C.V.
www.peri.com.mx
- PA** Panama
PERI Panama Inc.
www.peri.com.pa
- US** USA
PERI Formwork Systems, Inc.
www.peri-usa.com

South America

- AR** Argentina
PERI S.A.
www.peri.com.ar
- BR** Brazil
PERI Formas e Escoramentos Ltda.
www.peribrasil.com.br
- CL** Chile
PERI Chile Ltda.
www.peri.cl
- CO** Colombia
PERI S.A.S.
www.peri.com.co
- PE** Peru
PERI Peruana S.A.C.
www.peri.com.pe

Africa

- AO** Angola
Pericofragens, Lda.
www.peri.pt
- DZ** Algeria
S.A.R.L. PERI
www.peri.dz
- EG** Egypt
Egypt Branch Office
www.peri.com.eg
- MA** Morocco
PERI S.A.
www.peri.ma
- MZ** Mozambique
PERI (Pty.) Ltd.
www.peri.co.mz
- NA** Namibia
PERI (Pty.) Ltd.
www.peri.na
- NG** Nigeria
PERI Nigeria Ltd.
www.peri.ng
- TN** Tunisia
PERI S.A.U.
www.peri.es
- TZ** Tanzania
PERI Formwork and Scaffolding Ltd
www.peri.co.tz
- ZA** South Africa
PERI Formwork Scaffolding (Pty) Ltd
www.peri.co.za

Asia

- AE** United Arab Emirates
PERI (L.L.C.)
www.peri.ae
- AZ** Azerbaijan
PERI Representative Office
www.peri.com.tr
- HK** Hong Kong
PERI (Hong Kong) Limited
www.perihk.com
- ID** Indonesia
PT Beton Perkasa Wijaksana
www.betonperkasa.com
- IL** Israel
PERI F.E. Ltd.
www.peri.co.il
- IN** India
PERI (India) Pvt Ltd
www.peri.in
- IR** Iran
PERI Pars. Ltd.
www.peri.ir
- JO** Jordan
PERI GmbH – Jordan
www.peri.com
- JP** Japan
PERI Japan K.K.
www.peri.co.jp
- KR** Korea
PERI (Korea) Ltd.
www.perikorea.com
- KW** Kuwait
PERI Kuwait W.L.L.
www.peri.com.kw
- KZ** Kazakhstan
TOO PERI Kazakhstan
www.peri.kz
- LB** Lebanon
PERI Lebanon Sarl
lebanon@peri.de
- MY** Malaysia
PERI Formwork Malaysia Sdn. Bhd.
www.perimalaysia.com
- OM** Oman
PERI (L.L.C.)
www.peri.ae
- PH** Philippines
PERI-Asia Philippines, INC.
www.peri.com.ph
- QA** Qatar
PERI Qatar LLC
www.peri.qa
- SA** Saudi Arabia
PERI Saudi Arabia Ltd.
www.peri.com.sa
- SG** Singapore
PERI Asia Pte Ltd
www.periasia.com
- TH** Thailand
Peri (Thailand) Co., Ltd.
www.peri.co.th
- TR** Turkey
PERI Kalıp ve İskeleleri
www.peri.com.tr
- VN** Vietnam
PERI ASIA PTE LTD
www.peri.com.vn



PERI

PERI GmbH
Formwork Scaffolding Engineering
Rudolf-Diesel-Strasse 19
89264 Weissenhorn
Germany
Tel. +49 (0)7309.950-0
Fax +49 (0)7309.951-0
info@peri.com
www.peri.com

Oceania

AU Australia
PERI Australia Pty. Ltd.
www.periaus.com.au

DK Denmark
PERI Danmark A/S
www.peri.dk

IT Italy
PERI S.r.l.
www.peri.it

SE Sweden
PERI Sverige AB
www.peri.se

Europe

EE Estonia
PERI AS
www.peri.ee

LT Lithuania
PERI UAB
www.peri.lt

SI Slovenia
PERI oplate i skele d.o.o
www.peri.com.hr

AL Albania
PERI Kalıp ve İskeleleri
www.peri.com.tr

ES Spain
PERI S.A.U.
www.peri.es

LU Luxembourg
N.V. PERI S.A.
www.peri.lu

SK Slovakia
PERI spol. s. r.o.
www.peri.sk

AT Austria
PERI Ges.mbh
www.peri.at

FI Finland
PERI Suomi Ltd. Oy
www.perisuomi.fi

LV Latvia
PERI SIA
www.peri-latvija.lv

UA Ukraine
TOW PERI
www.peri.ua

BA Bosnia and Herzegovina
PERI oplate i skele d.o.o
www.peri.com.hr

FR France
PERI S.A.S.
www.peri.fr

NL Netherlands
PERI b.v.
www.peri.nl

BE Belgium
PERI N.V.
www.peri.be

GB United Kingdom
PERI Ltd.
www.peri.ltd.uk

NO Norway
PERI Norge AS
www.peri.no

BG Bulgaria
PERI Bulgaria EOOD
www.peri.bg

GR Greece
PERI Hellas Ltd.
www.perihellas.gr

PL Poland
PERI Polska Sp. z o.o.
www.peri.com.pl

BY Belorussia
IOOO PERI
www.peri.by

HR Croatia
PERI oplate i skele d.o.o.
www.peri.com.hr

PT Portugal
Pericofragens Lda.
www.peri.pt

CH Switzerland
PERI AG
www.peri.ch

HU Hungary
PERI Kft.
www.peri.hu

RO Romania
PERI România SRL
www.peri.ro

CZ Czech Republic
PERI spol. s r.o.
www.peri.cz

IR Ireland
Siteserv Access & Formwork
www.siteservaccess.ie

RS Serbia
PERI oplate d.o.o.
www.peri.rs

DE Germany
PERI GmbH
www.peri.de

IS Iceland
Armar ehf.
www.armor.is

RU Russia
OOO PERI
www.peri.ru

**The optimal System
for every Project and
every Requirement**



Wall Formwork



Column Formwork



Slab Formwork



Climbing Systems



Bridge Formwork



Tunnel Formwork



Shoring Systems



Construction Scaffold



Facade Scaffold



Industrial Scaffold



Access



Protection Scaffold



Safety Systems



**System-Independent
Accessories**



Services



PERI GmbH
Formwork Scaffolding Engineering
 Rudolf-Diesel-Strasse 19
 89264 Weissenhorn
 Germany
 Tel. +49 (0)7309.950-0
 Fax +49 (0)7309.951-0
 info@peri.com
 www.peri.com

